

A611238

Ugaoni ventil

Angle valve

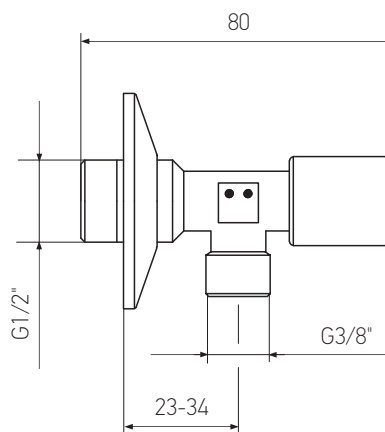

SLIKA PROIZVODA
I TEHNIČKI CRTEŽ

PRODUCT PICTURE &
TECHNICAL DRAWING

TEHNIČKI PODACI

Masivna konstrukcija
Kompresioni gornji deo
ROSAN hromirani rukohvat
Klizna rozeta od Inoxa AISI 304

TECHNICAL DETAILS

Massive construction
Compression cartridge
ROSAN chromed handle
AISI 304 Stainless steel rosette

RADNI USLOVI ARMATURA

- Maksimalni radni pritisak **5 bar**
- Preporučeni radni pritisak **3 bar**
- Minimalni radni pritisak **1 bar**
- Maksimalna dozvoljena temperatura **80°C**
- Preporučena temperatura vode **60°C**

WORKING REQUIREMENTS

- Max. operating pressure **5 bar**
- Recommended operating pressure **3 bar**
- Minimum operating pressure **1 bar**
- Maximum operating temperature **80°C**
- Recommended operating temperature **60°C**